

HELICAL SCREW SCREEN FOR SMALL FLOW AND PUMPING STATION REF: TA – HEL - MINI

Application:

- Solids (equal or larger than 15 mm) removal.

Characteristics:

- Manufactured in AISI 304 stainless steel, provided with a perforated screening plate with an opening size of 15 mm (Different screen opening sizes on request).
- Shaftless screw manufactured in carbon steel micro alloy.
- Can be fitted into the pipeline connection.
- Gear motor of 0, 25 kW.
- Optional: level switch.
- No service operations required for refuse screening and recovery.

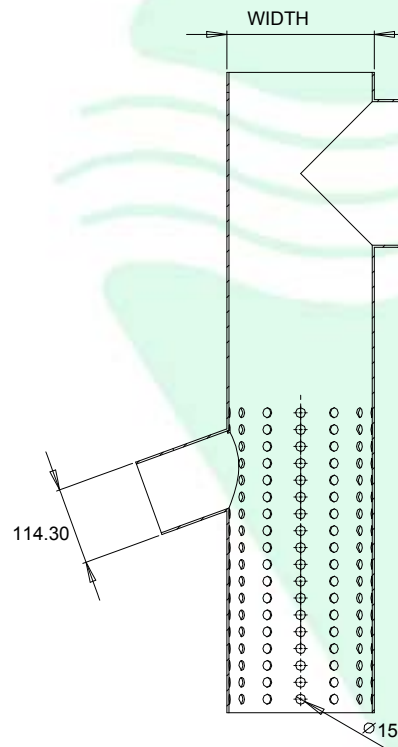
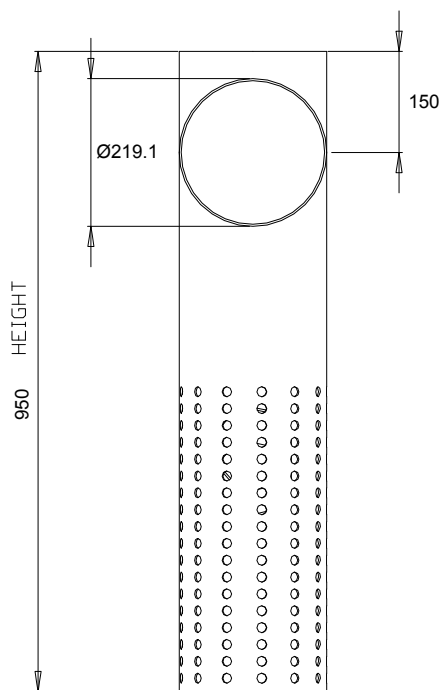
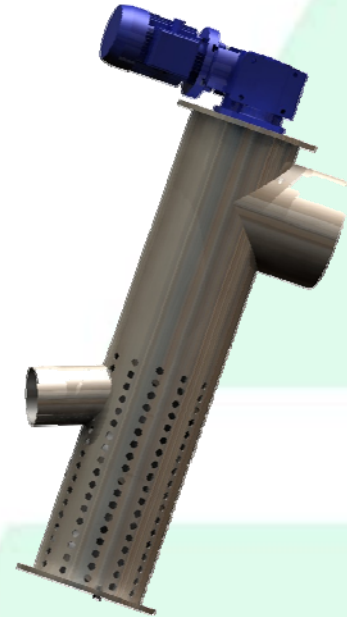

REF.	HEIGHT [mm]	WIDTH [mm]	POW. (kW)	SCREEN OPENING [mm]	FLANGES Inlet / Outlet [mm]
TA-HEL-Mini	950	219	0.25	15	114.30 / 219,10

TANK FOR TAL-HEL-MINI (optional)

- Glass Fiber Reinforced Polyester (GFRP) tank with a storage compartment.

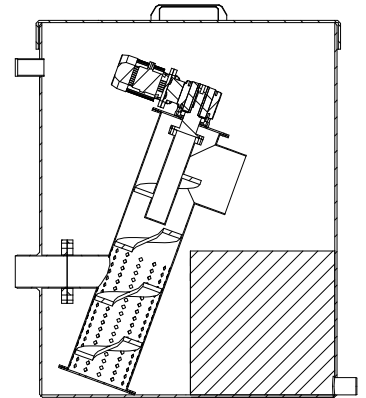
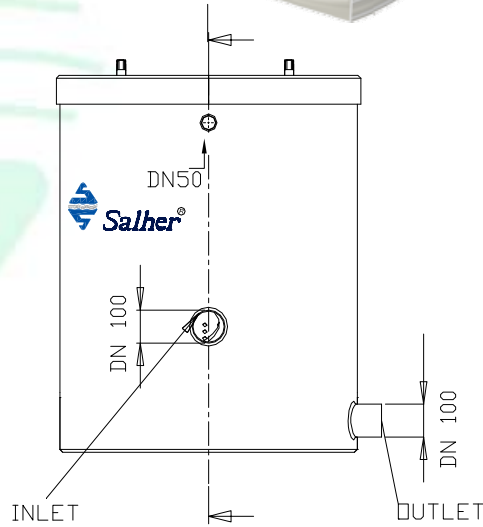
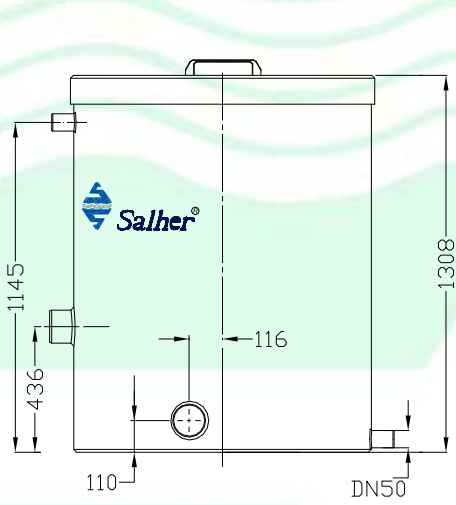
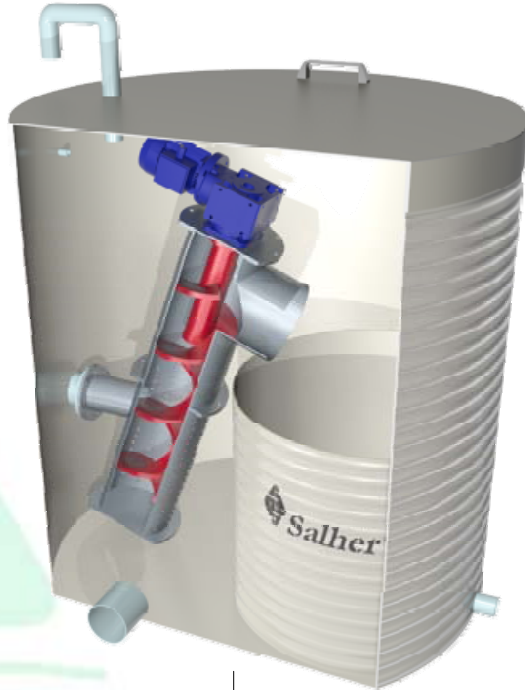

REF.

Mini TAHEL TANK

REF.

Mini TAHEL Panel board
(optional)